

VAMAV[®]

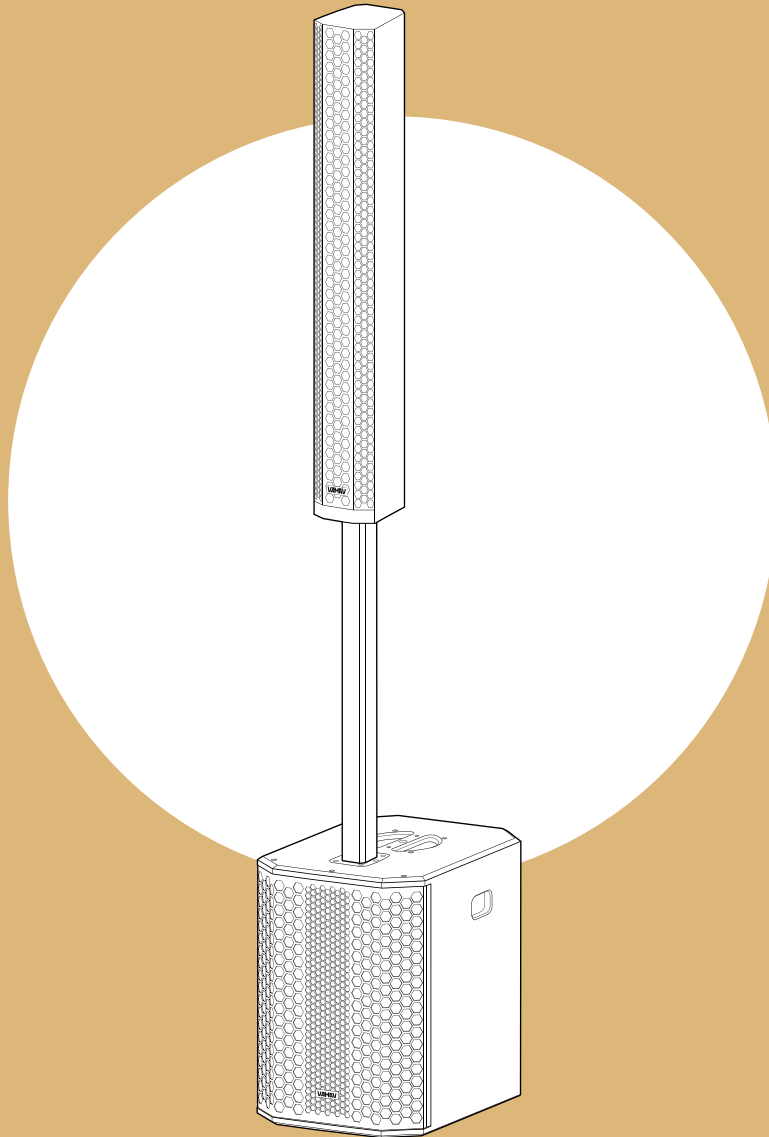

POWERED COLUMN PA SPEAKER USER MANUAL

XPECTRA1225

TABLE OF CONTENTS

Thanks for Choosing **VAMAV**[®]

What is Included	03
Rear Panel Instructions	04
DSP Settings	07
Safety Precautions	08
Specifications	11
Troubleshooting	12

WHAT IS INCLUDED?

- 1 Xpectra1225 Subwoofer
- 1 Xpectra1225 Satellite Speaker
- 1 Spacer
- 1 User Manual
- 1 Power Cable
- 1 Warranty Card

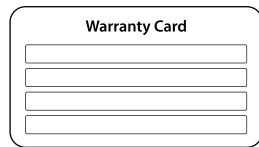
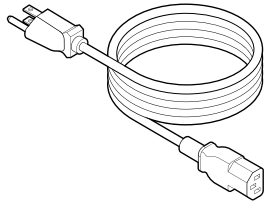
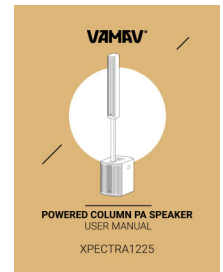
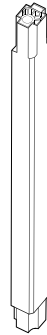
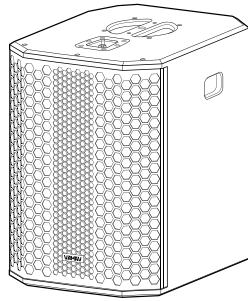
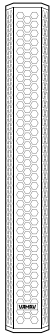

REAR PANEL INSTRUCTIONS

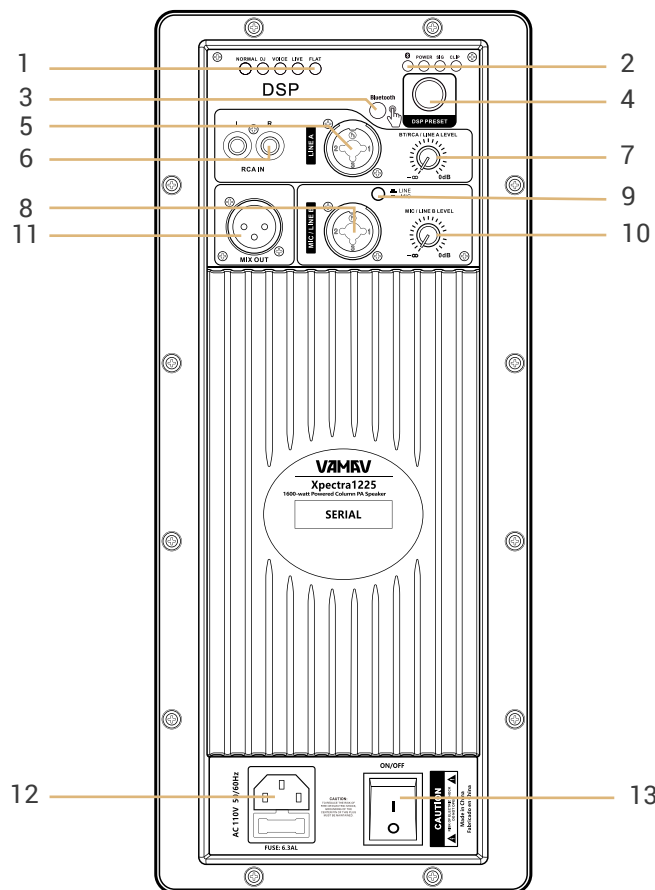

- 1 DSP MODE LEDs:** One of the LEDs illuminates to indicate which DSP mode is in use.
- 2 Operating LEDs:**
 - **Bluetooth LED:** Illuminates when Bluetooth is active.
 - **Power LED:** Illuminates when the speaker is powered on.
 - **SIG LED:** Illuminates when an input signal is present.
 - **CLIP LED:** Illuminates when the signal is clipping. If clipping occurs, the input volume should be reduced to prevent distortion and potential damage.
- 3 Bluetooth ON/OFF:** Controls the Bluetooth feature. To enter pairing mode: Press it for 3-5 seconds until the Bluetooth indicator flash. Then, select the speaker from the device list.
- 4 DSP PRESET:** Rotate the knob to select from the various DSP modes.
- 5 LINE A:** Combination 1/4" / XLR input jack for line-level inputs.
- 6 RCA IN:** Unbalanced stereo line input.

- 7 **BT/RCA/LINE A LEVEL:** Volume control for the Bluetooth, RCA, and LINE A inputs.
- 8 **MIC/LINE B:** Combination 1/4" / XLR input jack for input from a line-level source or a dynamic microphone.
- 9 **LINE/MIC:** Button to switch the MIC/LINE B input sensitivity between line level and microphone level.
- 10 **MIC/LINE B LEVEL:** Volume control for the MIC/LINE B input.
- 11 **MIX OUT:** Line-level output for connecting another speaker
- 12 **Power cord input:** Before connecting the power cord, check if the mains voltage corresponds to the voltage indicated on the rating plate of the unit. Connect the power cord only to a mains socket outlet with a protective earthing connection.
- 13 **Power Switch:** ON/OFF function

Bluetooth Connection Guide for Xpectra1225

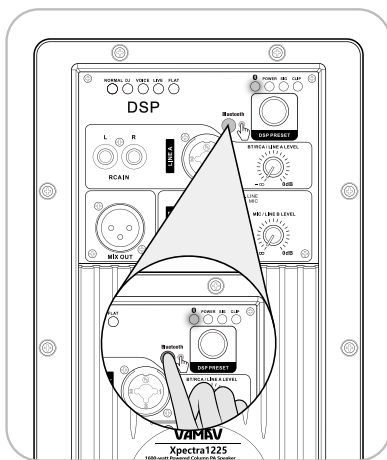

1. Press the Bluetooth button on the rear panel, and indicates the Bluetooth LED light flashes.

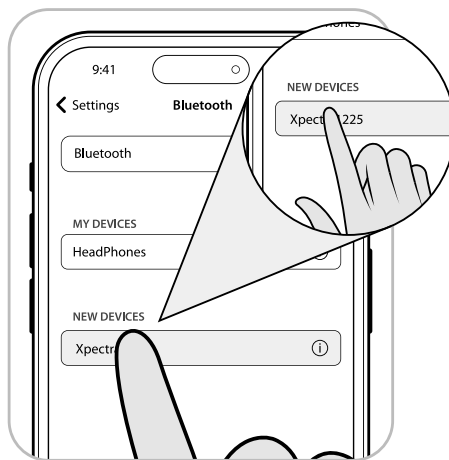

2. Scroll through the list of available devices and tap on the column labeled "**Xpectra1225**" to establish a connection.

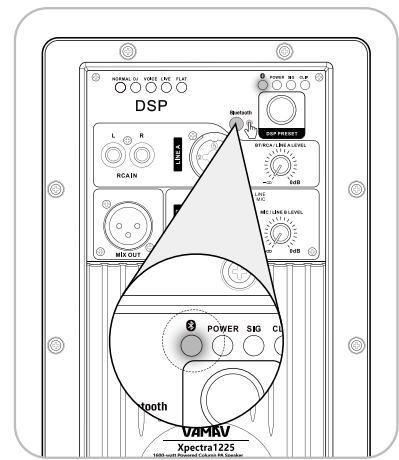

3. Speaker plays sound when connected successfully, Bluetooth LED light turns to a steady state.

Pair with Another Xpectra1225

The True Wireless Stereo (TWS) feature allows you to wirelessly connect 2 Xpectra1225 to create a complete stereo environment.

1. Ensure that both devices are powered on.
2. Connect a Bluetooth playback device to Speaker A.
3. Start with Speaker A, which will become the right(R) channel in stereo mode. Press and hold the Bluetooth button on Speaker A until the blue light on the back panel starts flashing, indicating it has entered pairing mode. The pairing window lasts about 30 seconds.
4. If the TWS pairing is successful, you will hear a "ding dong" confirmation sound, and the Bluetooth indicator on Speaker A will flash intermittently, while the Bluetooth indicator on Speaker B will remain solid, indicating a stable connection.

Once successfully paired, the two speakers will automatically reconnect upon the next power-up.

Please note:

1. This feature does not automatically sync EQ adjustments or sound from non-Bluetooth devices like XLR cables. Users need to manually adjust the EQ settings for each speaker according to their needs.
2. If an input device (such as a microphone, instrument, or other audio source) is plugged into one of the speakers using an XLR 1/4" combo jack, only that speaker will output the audio from the input device. The second speaker connected through TWS won't play this audio.
3. This feature does not support changing the channel assignment of the main speaker through DSP settings.

Switching Bluetooth Devices in TWS Mode

1. Disconnect Current Device

In the TWS mode, to switch the Bluetooth playback device, begin by manually disconnecting the Bluetooth connection on the device currently in use (Device A). This can typically be done through the Bluetooth settings menu on Device A. Select the Xpectra1225 speaker from the list of connected devices and choose "**Disconnect**" or similar option. Or, turn off Device A.

2. Pair New Device

Turn to the new device (Device B) with which you want to establish a connection. Go to the Bluetooth settings on Device B, search for the Xpectra1225, and select it to establish a new connection.

How to Disconnect TWS

To disconnect the TWS connection, press and hold the Bluetooth button on one of the speakers for more than 3 seconds

DSP SETTINGS

Adjusting DSP Modes

The speaker offers a convenient, straightforward way to switch between different DSP (Digital Signal Processor) presets using just two components: the rotary knob and the mode indicator light.

Procedure

1. Locate the Rotary Knob: Find the rotary knob on the back panel of the speaker.

2. Select DSP Modes: Turn the rotary knob to cycle through the available DSP modes.

The modes include:

- **Normal:** Optimized for general listening experiences.
- **DJ:** Tailored for dynamic bass and enhanced sound delivery, perfect for music events.
- **Voice:** Enhanced clarity for spoken words, ideal for speeches or presentations.
- **Live:** Adjusts settings for live music performances, emphasizing both vocals and instruments.
- **Flat:** Provides a neutral output with no enhancements, suitable for audio purists and professional mixing.

3. Check the Indicator Light: The mode indicator light located near the rotary knob will change according to the selected mode.



SAFETY PRECAUTIONS

General Safety

1. Do not use solvents or cleaners based on petrochemicals to clean the speaker.
2. Do not place objects that emit heat, such as lighting equipment or smoke machines, on the speaker cabinet.
3. Do not expose the speaker to direct rain or standing water to prevent the risk of electrical shorts and other hazards.
4. Regularly check the connection points and electrical contacts, including those on the spacer, for signs of wear, corrosion, or damage. Address any issues promptly to maintain optimal functionality and safety.
5. Do not handle any of the system's electrical connections with wet hands or while standing in water. Ensure that both your environment and your hands are dry when manipulating the system's components.
6. Do not lean on the satellite speaker. Excessive force or weight on the satellite can cause it and the spacer to become unstable or fall, damaging the metal contacts, the speaker components themselves, and more importantly, can lead to injuries.
7. Always ensure that the system is placed on a stable, flat surface. Inclined or uneven surfaces can cause the system to topple over, potentially leading to injury and damage to the equipment.

Handling Precautions

1. Do not stack the speakers unsafely as it may result in them toppling and causing injury or damage.
2. Do not use the built-in handles for rigging. They are for transportation purposes only.

Connection Safety

- Before any connection is made, ensure that all contact points, sockets on the subwoofer and line array speakers, and especially the contacts on the provided spacer, are completely dry. It is crucial to avoid any moisture at these connection points to prevent electrical safety incidents.
- Inspect the line array speaker socket located at the bottom of the speaker and the corresponding socket at the top of the subwoofer, along with the spacer's contacts, for any signs of moisture or debris. Clean and dry these areas thoroughly if necessary before proceeding with the installation.

Handling Moisture and Condensation

- Avoid exposing the speaker sockets, electrical contacts, and particularly the spacer's contacts to water or humidity. Moisture in these components can lead to various issues, ranging from reduced performance, such as no sound output, to severe electrical hazards, including the risk of electrical shock.
- Always store and operate the line array PA system in environments that are free from excessive moisture. If the equipment has been exposed to moisture, allow it to dry completely and ensure all contacts are dry before connection and use.

Additional Safety Precautions for Auto-Amplified Devices

Electrical Integrity

- Do not install the subwoofer without first ensuring that the electrical output matches the subwoofer's requirements.
- Always disconnect the subwoofer from the power supply before you start any connections.
- Do not let the power cord become crimped or damaged. Avoid contact with other cables and always handle the power cord by the plug.
- Do not replace the fuse with one of different specifications. Always use a fuse of the same rating and dimensions.

Operational and Environmental Conditions

- Do not cover the subwoofer with anything or place it in poorly ventilated areas to avoid overheating and potential fire risk.
- Avoid placing the subwoofer in environments with corrosive gases or salty air, which could lead to malfunctions.
- Do not expose your ears to high sound levels from the subwoofer for prolonged periods without protection to prevent hearing loss.
- Do not continue to use the subwoofer if it produces distorted sound, as this may lead to overheating and potentially a fire.

Handling and Installation

- Do not use the subwoofer's handles to hang it.
- Do not lift subwoofers heavier than 20 kg (45 lb) alone. Use team lifting to prevent injuries.
- Do not leave cables unsecured. Manage cables properly to avoid tripping hazards by securing them with tape or ties, especially across walkways.



Do not dispose of this product with household waste. The symbol on the product or its packaging indicates it should be taken to an appropriate collection point for recycling. Proper disposal helps prevent potential environmental damage and health hazards while conserving natural resources. For more detailed information about recycling this product, please contact your local city office, your household waste disposal service, or the shop where you purchased the product.

User Information

- Please read the user manual thoroughly before connecting or operating your new VAMAV loudspeaker, paying special attention to the sections about operational precautions and wiring.

VAMAV Inc. reserves the right to make changes without prior notice in order to correct any errors and/or omissions.

Please always consult the most recent version of the manual at www.VAMAV.com.

FCC WARNING

This device complies with Part 15 of the FCC rules. Operation is subject to the following two conditions:



1. This device may not cause harmful interference.
2. This device must accept any interference received, including interference that may cause undesired operation.

SPECIFICATIONS

RMS Power	800W
Maximum Power	1600W
Max SPL	129dB
Subwoofer	12-inch with 2.5-inch 75oz voice coil
Satellite Speakers	8pcs 3.5" neo woofer
Frequency Response	50Hz-20kHz
Voltage	110v-240v 50/60Hz
Amplifier	Class D DSP
With Display	No
Wireless Connectivity	Yes, support TWS
Product Dimension(LxWxH)	35x47.5x49 cm / 13.8x18.7x19.3 inches(Subwoofer) 88x12x15 cm / 34.6x4.5x5.9 inches(Satellite speaker)
Product Weight	20.8 kg / 45.9 lb (Subwoofer) 7.1 kg / 15.7 lb (Top)



TROUBLESHOOTING

Problems	Solutions
<p>The power won't turn on.</p>	<ul style="list-style-type: none"> • Check Connections: Ensure that the power cord is securely and safely plugged into both the speaker and the power outlet. • Power Switch: Verify that the power switch is turned on.
<p>No sound is produced.</p>	<ul style="list-style-type: none"> • Level Settings: Check if the input source level knob is turned all the way down. Adjust all volume controls appropriately within the system, and ensure that the mixer is receiving a signal by observing the level meter. • Signal Source: Confirm that the signal source is operational. • Cable Integrity: Inspect all connecting cables for damage and ensure they are securely connected at both ends. The output level control on the mixer should be high enough to drive the Subwoofer inputs. • Mixer Settings: Make sure the mixer is not muted or a processor loop is not engaged. If any of these settings are on, turn the level down before disengaging. • The line array speaker does not produce sound when connected with the spacer: Ensure that the line array speakers and spacer are firmly inserted into their respective sockets to facilitate full contact and sound output.

Problems	Solutions
<p>Distorted sound or noise is present.</p>	<ul style="list-style-type: none"> • Volume Levels: Check if the level knobs for relevant channels and/or the master level control are set too high. • MIC/LINE Switch: If the input signal from the source is high, setting the switch to MIC might cause distortion. Set the switch to LINE. • External Device Volume: Lower the volume of the connected device if it's too high.
<p>The sound is not loud enough.</p>	<ul style="list-style-type: none"> • Volume Levels: Confirm that the level knobs for relevant channels and/or master level are not set too low. • MIC/LINE Switch: If set to LINE, reduce the level control knobs to the minimum (zero), switch to MIC, and gradually increase the level. • Device Volume: Increase the output volume of the connected devices if too low.
<p>Hum is heard.</p>	<ul style="list-style-type: none"> • Disconnecting Cables: Disconnect the cable from the input jack to check if the hum stops, indicating a possible ground loop issue rather than a subwoofer fault. • Use Balanced Connections: Utilize balanced connections across your system for optimal noise rejection. • Common Grounding: Ensure that all audio equipment is plugged into outlets with a common ground, keeping the distance as short as possible between the common ground and outlets. • MIC/LINE Switch: Make sure the LINE/MIC switch on the back panel has switched to "LINE".



TROUBLESHOOTING - **BLUETOOTH**

Problems	Solutions
Bluetooth connection issues	<ul style="list-style-type: none">• Ensure Bluetooth is enabled on your device.• Make sure the subwoofer is in pairing mode.• Move the Bluetooth device closer to the subwoofer.• Check for interference from other Bluetooth devices.

WWW.VAMAV.COM

Looking for help? Contact us to get support.

support@us.vamav.com

www.vamav.com